

COOLEEDGE™

COOLEEDGE TILE TUNABLE WHITE - SPECIFICATIONS

PROJECT		REFERENCE TYPE	
SPECIFIED BY		QUANTITY	
DATE		NOTE	For Luminous Surfaces

SYSTEM OVERVIEW

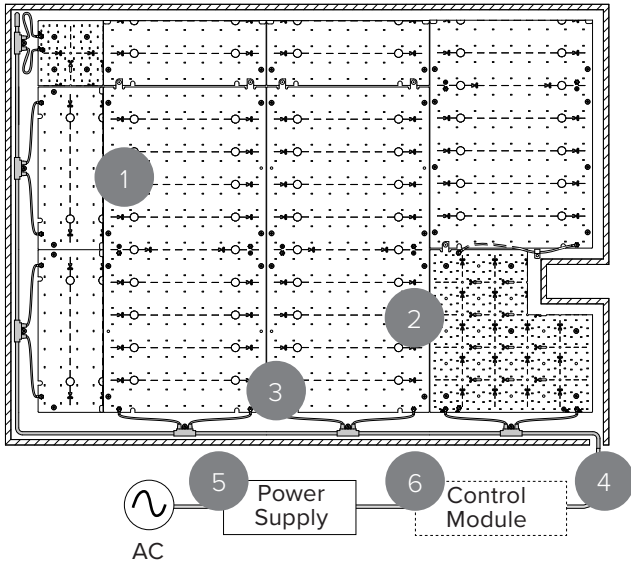

Replicate natural light both in scale and through dynamic changes in color temperature

1	TILE Tunable White
2	TILE Tunable White Cut-out Kit <i>(optional)</i>
3	TILE Tunable White T-Cable
4	TILE Tunable White Starter Cable*
5	Power Supply
6	Control Module

*Included in TILE Tunable White Starter Kit

GENERAL

Location	Indoor, dry location only
Operating Temp.	0-40°C
Storage Temp.	-40-85°C
Relative Humidity	90% max (non-condensing)
Input Voltage (to power supply)	120-277 VAC
Electrical Connections	Tool-less snap connectors
Mounting Surface	Non-conductive* (drywall, plywood, etc)

*Mounting to a conductive surface may void warranty. Please contact Cooleedge if this is required

FEATURES

- Unique tunable white system design provides constant lumen output at all CCTs in the range 2700K-5700K and at all dimming levels
- Dim-to-warm option provides smooth dimming along the CCT curve to 0.10% from 3500K to 2200K
- Cooleedge Control Modules are available with inputs for 0-10V, DALI, DMX, and wireless (Casambi) protocols
- Uniquely suited for installations requiring high CRI such as retail and hospitality
- Cut-to-fit means systems are adaptable to any size installation and can accommodate obstacles and shapes

SPECIFICATION

CE Compliant lighting system inclusive of flexible light emitting sheets, connectors, low voltage cables, and power & controls. Light output from the system must be +/- 10% of 9680/6460/3230/1610 lumens/m² across the total illuminated area post-installation.

The lighting system must have a Color Rendering index (CRI) >90 and provide constant lumen output for all CCTs between 2700K-5700K and for all dimming levels. Electrical connections between cables and light emitting sheets must be tool-less and allow more than one connect/disconnect iteration. System must be configurable on-site and include the capability to accommodate obstacles, angles, and curves. System warranty is a minimum of 5 years.

COOLEGE TILE TUNABLE WHITE - SPECIFICATIONS

PHOTOMETRICS¹

Light Output (lm/m ²)	9680 ³ , 6460, 3230, 1610
Correlated Color Temperature (CCT)	Tunable White = 2700K-5700K Dim-to-Warm = 3500K-2200K
Color Rendering Index (CRI)	≥ 90 (except 2200K, CRI88)
Color Uniformity	2 SDCM (typical)
Lumen Maintenance ²	L80 = 75,000hr

¹ Photometric files available from cooledgelighting.com

² Based on LM80 data & TM-21 calculations

³ Not available in Dim-to-Warm

IESNA TM-30-18 DATA

CCT	Rf	Rg
2200K	91	99
2700K	91	100
3500K	88	97
5700K	87	97
DTW*	90	100
TNW*	89	100

* Denotes both channels @50%

POWER

Light Output (lm/m ²)	CCT	Power (W/m ²)	EcoDesign Class
9680	2700K	74.4	E
	3500K	N/A	
	5700K	66.7	
6460	2700K	50.0	E
	3500K	43.9	
	5700K	45.6	
3230	2700K	24.4	E
	3500K	21.7	
	5700K	21.7	
1610	2700K	12.2	E
	3500K	11.1	
	5700K	11.1	



CERTIFICATIONS



WARRANTY



5 Year Limited Warranty:
Parts and workmanship when
used with a Coledge approved
power supply.

1 TILE TUNABLE WHITE

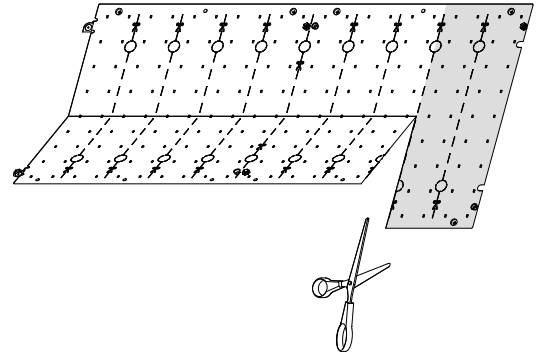
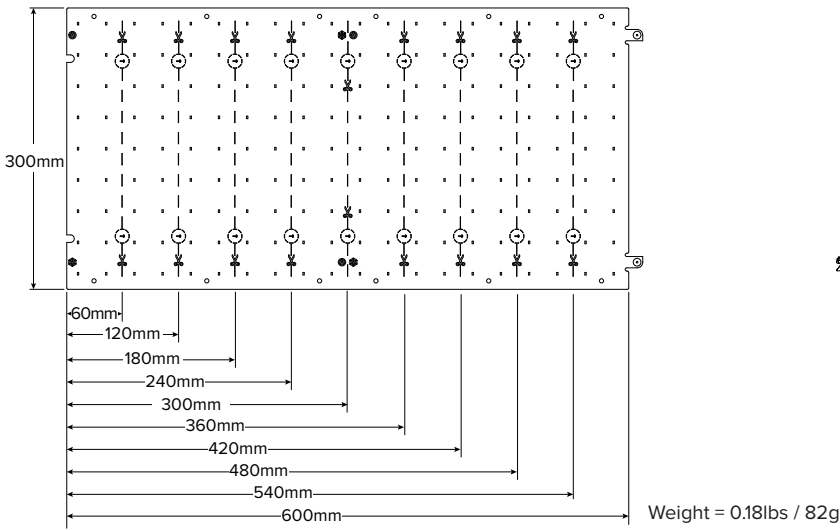

HOW TO ORDER

Example: TILE-TUN-600-TNW-R3

TILE	TUN	FLUX	CCT	R3*
PRODUCT TILE	TYPE TUN = Tunable White	900** = 9680lm/m ² (900lm per 300x300mm) 600 = 6460lm/m ² (600lm per 300x300mm) 300 = 3230lm/m ² (300lm per 300x300mm) 150 = 1610lm/m ² (150lm per 300x300mm)	TNW = 2700K-5700K DTW = 3500K-2200K	Version R3 = Revision 3

*May be identified as "C3" in some regions
**Not available in DTW

2 TILE TUNABLE WHITE CUT-OUT KIT

Purpose: Cut-to-fit around obstacles located in a luminous surface such as standoffs, support cables/rods, beams, pipes, etc.; used in corners where a full TILE does not fit in the space; or to step cut along angles and curves at the edge of a luminous surface. (Optional)

INCLUDED

- (1) Cut-out TILE (300mm x 300mm)
- (2) Insulating Patches
- (1) Cable Clamp
- (1) Single-connector Jumper Cable
- (1) Double-connector Jumper Cable

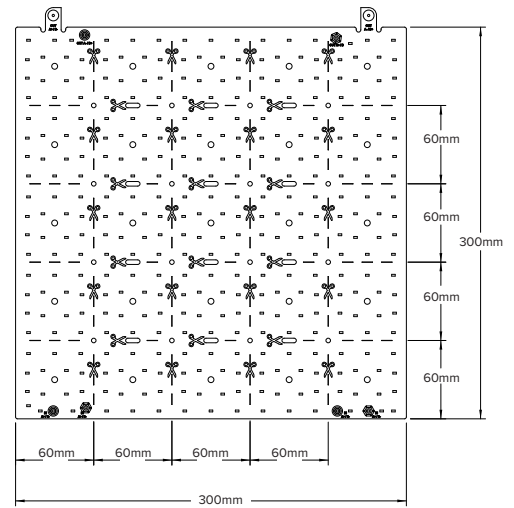
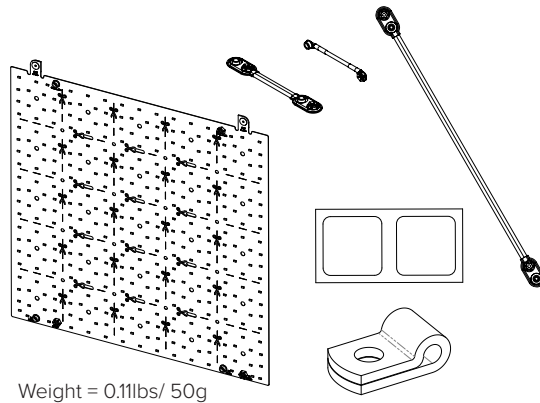

Weight = 0.10lbs / 45g

HOW TO ORDER

Example: TACC-TUN-CUT-600-TNW-K-R3

TACC	TUN	CUT	FLUX	CCT	K-R3*
PRODUCT TACC = TILE Accessory	TYPE TUN = Tunable White	COMPONENT CUT = Cut-out Kit	900** = 9680lm/m ² (900lm per 300x300mm) 600 = 6460lm/m ² (600lm per 300x300mm) 300 = 3230lm/m ² (300lm per 300x300mm) 150 = 1610lm/m ² (150lm per 300x300mm)	TNW = 2700K-5700K DTW = 3500K-2200K	KIT K = Kit Revision 3

*May be identified as "K-C3" in some regions
**Not available in DTW

3 TILE TUNABLE WHITE T-CABLE

Purpose: Makes the electrical connection to the first TILE in each run from the Starter Cable that supplies power from the power/control components. Each “T” connects to a TILE via snap connectors. (Required)

HOW TO ORDER

Example: TCBL - TUN-T10

TCBL	-	TUN	-	
PRODUCT			TYPE	
TCBL = TILE Cable			T4 = 4 T-Connectors (weight = .13lb/59g)	
			T10 = 10 T-Connectors (weight = .66lb/300g)	

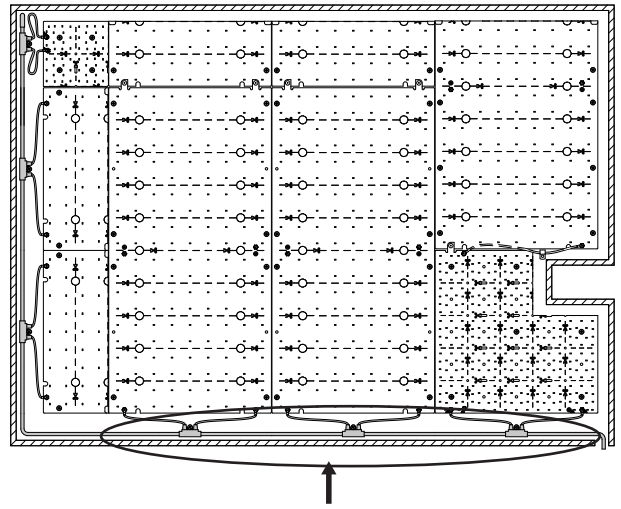

4 TILE TUNABLE WHITE STARTER KIT

Purpose: Includes the Starter Cable that makes the connection from the Control Module to the T-Cable and other accessories required for wire termination and connections. Insulation patches are required to cover areas of TILES where cuts have been made. (Required)

INCLUDED

- (2) Single-connector Cut TILE Reuse Jumper Cables
- (2) Double-connector Cut TILE Reuse Jumper Cables
- (2) Splice Connectors
- (4) End Caps
- (10) Insulating Patches
- (1) 10ft (3m) Starter Cable with Connector
- (1) Quick Start Guide

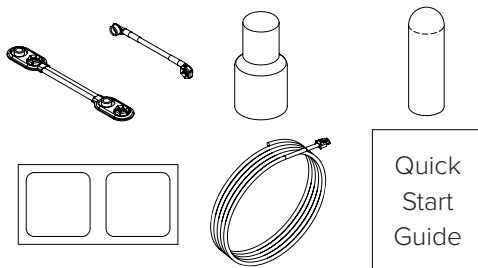
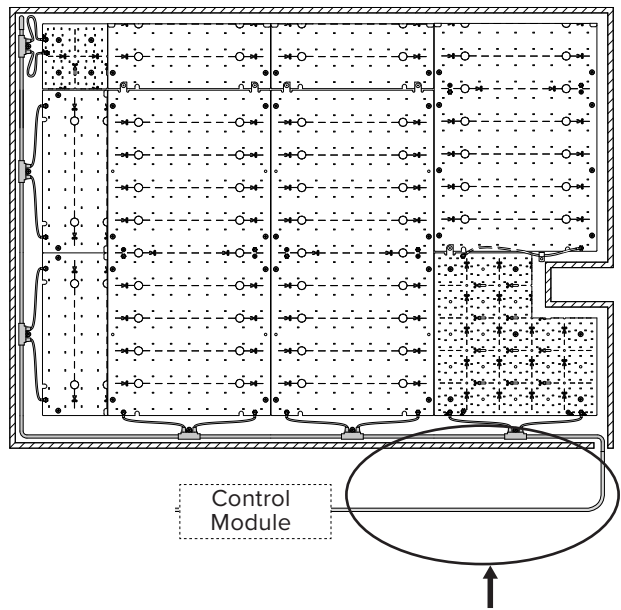

HOW TO ORDER

Example: TACC-TUN-STR-K

TACC	-	TUN	-	STR	-	K
PRODUCT			TYPE		KIT	
TACC = TILE Accessory			TUN = Tunable White		STR = Starter	
					K = Kit	

5 POWER AND CONTROL

Specifications for the power supplies and Cooledge Control Modules shown below are available in:

- Power and Control Specifications (UL Listed)

The models shown below are those that are compatible with TILE Tunable White Systems for regions where cUL Listed products are required.

POWER SUPPLIES (54V)

Purpose: Convert AC main (line) power to safe, low voltage DC power. Cooledge LED drivers are offered with range of dimming options. (Required)

Order Code	Description	# Controller Channels*	Integrated Wiring Enclosure
EPSS-400-54V-CE	400W Power Supply, 54V (CE Compliant) with integrated junction box	2 + 2**	Yes
EPSS-200-54V-CE	200W Power Supply, 54V (CE Compliant) with integrated junction box	2	Yes
EPSS-092-54V-CE	92W Power Supply, 54V, (CE Compliant) with integrated junction box	1	Yes

*Class 2 (max. 90W) output
3-wire connection to TILES

**Requires 2 Control Modules

COOLEGE CONTROL MODULES (54V)

Purpose: Receives 54VDC power from the power supply and converts it to max. 90W per channel of controlled output to drive TILE Interior sheets. Also receives input control signal to control dimming levels.

Order Code	Function	Protocols
CTR-TNW-DAL/010-48/58V	Tunable White	0-10V, DALI
CTR-TNW-DMX-48/58V	Tunable White	DMX
CTR-TNW-CAS-48/58V	Tunable White	Casambi (Wireless)
CTR-DTW-DAL/010-48/58V	Dim-to-Warm	0-10V, DALI
CTR-DTW-DMX-48/58V	Dim-to-Warm	DMX
CTR-DTW-CAS-48/58V	Dim-to-Warm	Casambi (Wireless)

ADDITIONAL ACCESSORIES

EXTENSION CABLES

- 16 AWG cable (non-plenum rated)
- Available in 10' & 20' lengths

Purpose: Cable between TILE Starter Cable and Control Module that extends the distance the Control Module and power supply may be remotely located away from the TILES. Please consult Coolege for additional information including requirements for plenum rated cables.

HOW TO ORDER

Example: TCBL - TUN - LNG - 10

TCBL	-	TUN	-	LNG	-	
<u>PRODUCT</u> TCBL = Extension Cable		<u>TYPE</u> TUN = Tunable White				<u>LENGTH</u> 10 = 10ft (3m) 20 = 20ft (6m)

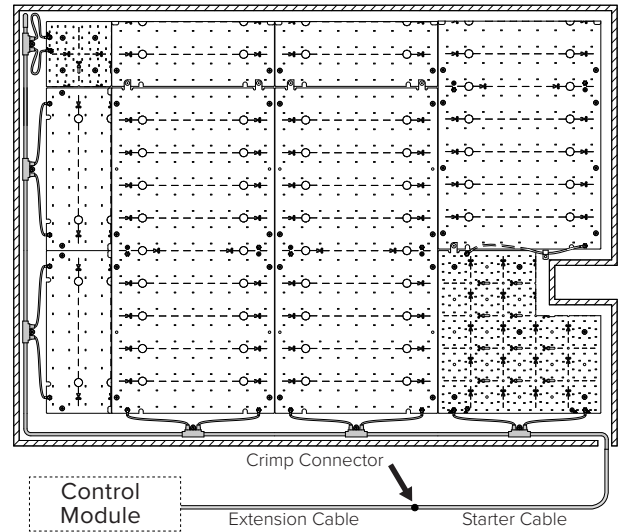

JUMPER CABLES

- 5 sets of double and single-connector jumper cables

Purpose: Allows a Tile to be cut in half and both portions connected in separate runs. Kit sufficient for 5 cut Tiles

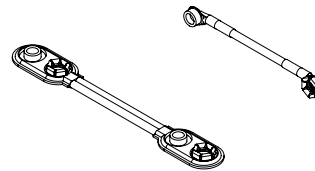

HOW TO ORDER

Example: TACC - TUN - JMP - 5

TACC	-	TUN	-	JMP	-	5
<u>PRODUCT</u> TACC = Jumper Cables		<u>TYPE</u> TUN = Tunable White				